



Caratteristiche: Fold, grazie alla profondità di soli 85 cm, è una collezione pensata per gli spazi contenuti e raffinati che si caratterizza nel suo design e nella sua personalità per una serie di cuciture che traggono ispirazione dal sistema di chiusura della busta. Fold si compone di divani, laterali, chaise longue, dormeuse e terminale da combinare in base alle proprie esigenze. Da sottolineare la doppia funzione che i moduli con bracciolo possono svolgere: quelli con un bracciolo possono essere utilizzati sia come laterale che come angolo; quelli con due braccioli sia come divano che come angolo laterale. Allo stesso modo la dormeuse può essere utilizzata come modulo indipendente o inserita come dormeuse angolo in una composizione. Completano l'offerta la poltrona, le cui dimensioni sono più ridotte rispetto agli altri moduli, i pouf, comodi cuscini e poggiatesta. A seconda del tipo di tessuto scelto la fodera si realizza in due diverse finiture: con cucitura ribattuta semplice o con "Punto Cavallo" (vedi pag.55). Il "Punto Cavallo" è un'impuntura decorativa disponibile in 11 colori (vedi pag.271 del Catalogo Generale o nel retrocopertina del listino prezzi) da abbinare a piacere al tessuto da scegliere fra quelli indicati come idonei. La finitura "Punto Cavallo" si fornisce con supplemento di prezzo. Fold, nella versione in Pelle, è disponibile nella sola finitura con ribattuta semplice e senza la tasca aperta posta sulla sommità del bracciolo (vedi pag.55). Il rivestimento è completamente e facilmente sfoderabile (ad eccezione della versione in Pelle) e i componibili vengono forniti di serie con un pratico sistema di aggancio. Fold si può attrezzare con i tavolini Blog; in particolare il tavolino Blog Alto, ideato appositamente per completare la collezione Fold, offre un valido piano d'appoggio all'altezza del bracciolo. **Struttura:** Fusto in legno massello e multistrato, molleggio con nastri elastici intrecciati. Il piede è in fusione disponibile nelle seguenti finiture: cromato, verniciato bianco opaco (RAL 9010), rosso opaco (RAL 3027) oppure grigio opaco (RAL 7022). **Imbottiture:** In poliuretano espanso indeformabile a densità differenziata. La seduta ha lo strato superiore in poliuretano Memory Foam e il tutto è ricoperto da uno strato di fibra poliestere, che dona un aspetto morbido e vissuto che va accettato in quanto voluto. Prerivestimento in tela bianca di cotone. I cuscini e i poggiatesta sono in piuma d'oca e anitra bianca vergine.

Features: Fold has been thought for limited but refined spaces, thanks to its depth of just mm 850, where its particular stitching, reminding the sealing of envelopes, characterize the design and personality of this collection. The range includes sofas, side pieces, chaise longue, dormeuse and end piece in order to answer to the different client's needs. To be emphasised is the double use of the modules with armrest: those with one armrest can be used as side- or corner pieces, while those with two arms work as sofas or as side corners. Likewise, dormeuse can be used either as a free-standing module or as a corner dormeuse when combined with other elements. Proportioned armchair, poufs comfortable cushions and lumbar cushions complete the range. According to the chosen fabric upholstery the cover can be delivered in two different finishes: single lapped seam or with Punto Cavallo (see catalogue p. 55). Punto Cavallo is a decorative stitching available in 11 colours (see page 271 of the general catalogue or in the back cover of the price list) to be matched at pleasure to fabric to choose from among those specified as suitable for this finish. There is an up charge for the Punto Cavallo option. Fold in the version in leather is available only in the finish with single lapped seam and without the open pocket placed on the upper part of the armrest (see catalogue p. 55). Covers are completely and easily removable (except for the leather version). For composition a practical connecting system is also provided. Fold can be completed with Blog small tables; in particular Blog Alto has been designed to complete the collection Fold, and offers a functional rest top at the armrest height.

Framework: Frame is in solid wood and plywood, sprung with interwoven elastic bands. Feet are in cast, available in four finishes: chrome, white-matt (RAL 9010), red-matt (RAL 3027) or grey-matt (RAL 7022) painted.

Padding: Fold is padded with differentiated density non-deformable polyurethane foam, the upper layer of the seat is in Memory Foam polyurethane finished with polyester fibre, giving a soft and aged appearance that must be accepted as it is intentional. Underlining in white cotton. Cushions and Lumbar Cushions are in goose and duck white, new feathers.

Eigenschaften: Dank seiner Tiefe von 85 cm, ist Fold eine Kollektion, die für etwas kleinere und elegante Räumlichkeiten gedacht ist. Ihre Nahtverarbeitung, die sich am Verschlussystem eines Kuverts inspiriert, charakterisiert ihr Design und ihre Persönlichkeit. Die Kollektion Fold bietet Sofas, Seitenteile, Chaiselongue, Dormeuse und Endelemente, die je nach Bedarf miteinander kombiniert werden können. Hervorzuheben sei die mögliche Doppelfunktion der Elemente mit Armlehne: Elemente mit einer Armlehne können sowohl als Seitenteil als auch als Eckelement eingesetzt werden; die Elemente mit zwei Armlehnen sowohl als Sofa als auch als Seiteneckteil. Ebenso kann die Dormeuse entweder als alleinstehendes Modul oder als Eckdormeuse gestellt werden. Ein Sessel, dessen Maße, im Vergleich zu den anderen Elementen der Kollektion, reduzierter sind, rundet, zusammen mit den Hockern, bequemen Wurf- und Lendenkissen, das Angebot ab. Je nach Stoffwahl kann der Bezug in zwei unterschiedlichen Verarbeitungen realisiert werden: einfache Kappnaht oder Ziernaht „Punto Cavallo“ (siehe Seite 55). Letztere ist in 11 Farben erhältlich (siehe Seite 271 des Hauptkatalogs bzw. Deckblatt-Innenseite unserer Preisliste) und kann nach Wunsch mit den dafür geeigneten Stoffen kombiniert werden. Die Verarbeitung mit Punto Cavallo ist mit einem Aufpreis verbunden. In Leder ist das Modell Fold nur mit einfacher Kappnaht und mit geschlossener Falte auf der Oberseite der Armlehne erhältlich (siehe Seite 55). Der Bezug ist leicht und vollständig abnehmbar (Lederversion ausgenommen) und die Anbauelemente sind serienmäßig mit einem praktischen Verbindungssystem ausgestattet. Fold kann mit den Beistellischen Blog ergänzt werden, insbesondere mit Blog Alto, der speziell für die Kollektion Fold gedacht ist und der eine ideale Ablagefläche in Höhe der Armlehne bietet. **Struktur:** Korpus aus Massiv- und Mehrschichtholz. Federung mit geflochtenen elastischen Gurten. Das gegossene Fußgestell ist in folgenden Ausführungen erhältlich: verchromt, mattlackiert in Weiß (RAL 9010), Rot (RAL 3027) oder Grau (RAL 7022). **Polsterungen:** Formstabiles Polyurethan mit differenzierten Dichten, wobei die obere Schicht des Sitzkissens aus Polyurethan „Memory Foam“ besteht und das Ganze eine Schicht Polyesterfaser überzieht, das ein weiches und „gelebtes“ Aussehen verleiht, das gewollt ist und als solches akzeptiert werden muss. Schonbezug aus weißer Baumwolle. Die Füllung der Wurf- und Lendenkissen ist aus neuen weißen Gänse- und Entenfedern.

PIEDE FOOT FUSS

Fusione di metallo verniciato opaco color bianco (RAL 9010);
fusione di metallo verniciato opaco color rosso (RAL 3027);
fusione di metallo verniciato opaco color grigio (RAL 7022);
fusione di metallo finitura a cromo.

Feet in cast finishing white-matt (RAL 9010) painted;
feet in cast finishing red-matt (RAL 3027) painted;
feet in cast finishing grey-matt (RAL 7022) painted;
feet in cast finishing chrome.

Fuß in Metallguß mattlackiert Weiß (RAL 9010);
Fuß in Metallguß mattlackiert Rot (RAL 3027);
Fuß in Metallguß mattlackiert Grau (RAL 7022);
Fuß in Metallguß verchromt.

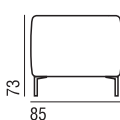
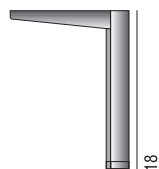

FIANCO

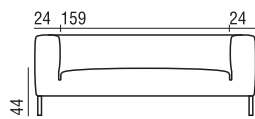

FRONTE

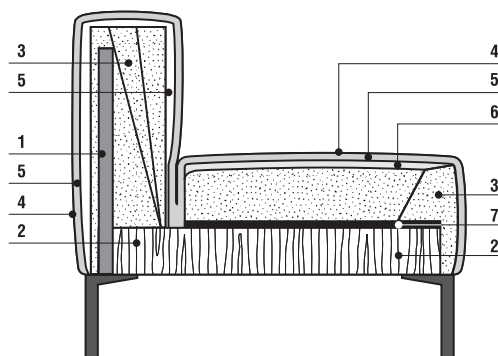

SEZIONE SECTION SEKTION

1. Pannello multistrato. Plywood base-panel. Mehrschichtholz.
2. Fusto in legno massello e multistrato. Frame in solid wood and plywood. Korpus aus Massiv- und schichtverleimtem Holz.
3. Poliuretano a densità differenziata. Differentiated density polyurethane. Polyurethan unterschiedlicher Dichte.
4. Fodera in tela. Fabric lining. Stofffutter.
5. Fibra Poliestere. Polyester Fibre. Polyesterfaser.
6. Poliuretano Memory Foam. Polyurethane Memory Foam. Polyurethan Memory Foam.
7. Nastri elastici intrecciati. Elastic belts interwoven. Geflochtene elastische Gurte.

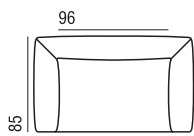

144
DIVANO 144
LATERALE ANGOLO 144 DX - SX

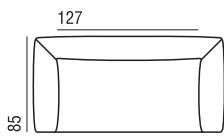

175
DIVANO 175
LATERALE ANGOLO 175 DX - SX

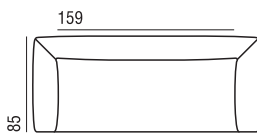

207
DIVANO 207
LATERALE ANGOLO 207 DX - SX

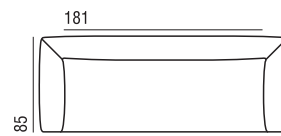

229
DIVANO 229
LATERALE ANGOLO 229 DX - SX

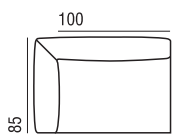

124
LATERALE 124 SX
ANGOLO 124 SX

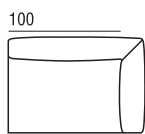

124
LATERALE 124 DX
ANGOLO 124 DX

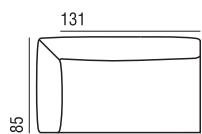

155
LATERALE 155 SX
ANGOLO 155 SX

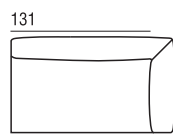

155
LATERALE 155 DX
ANGOLO 155 DX

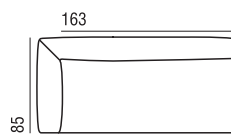

187
LATERALE 187 SX
ANGOLO 187 SX

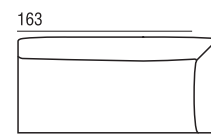

187
LATERALE 187 DX
ANGOLO 187 DX

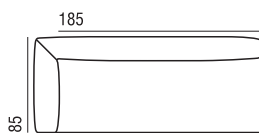

209
LATERALE 209 SX
ANGOLO 209 SX

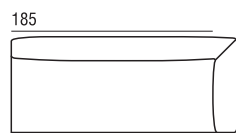

209
LATERALE 209 DX
ANGOLO 209 DX

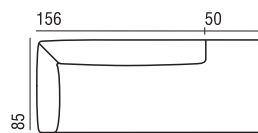

206
DORMEUSE 206 SX

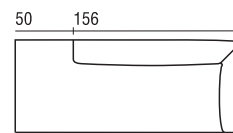

206
DORMEUSE 206 DX

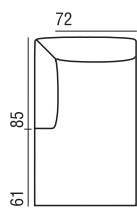

96
CHAISE LONGUE SX

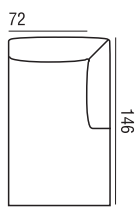

146
CHAISE LONGUE DX

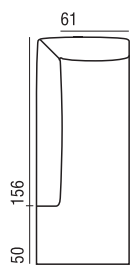

151
DORMEUSE ANGOLO SX

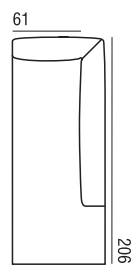

206
DORMEUSE ANGOLO DX

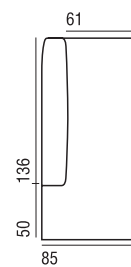

136
TERMINALE 186 SX

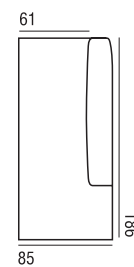

186
TERMINALE 186 DX

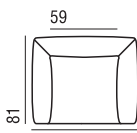

99
POLTRONA

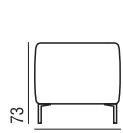

81
FIANCO

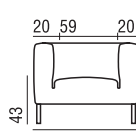

99
FRONTE

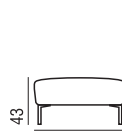

85
FIANCO POUF

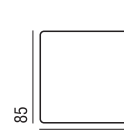

85
POUF 85x85



85
POUF 62x85



42
CUSCINO 42x42



54
CUSCINO 54x33

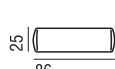

86
CUSCINO POGGIARENI 86

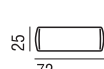

72
CUSCINO POGGIARENI 72



56
CUSCINO POGGIARENI 56



40
CUSCINO POGGIARENI 40

Descrizione composizioni fotografate - Description of the photographed combinations - Beschreibung der gebildeten Zusammenstellungen

Foto pagina - photo at page - Bid auf Seiten: 6/7

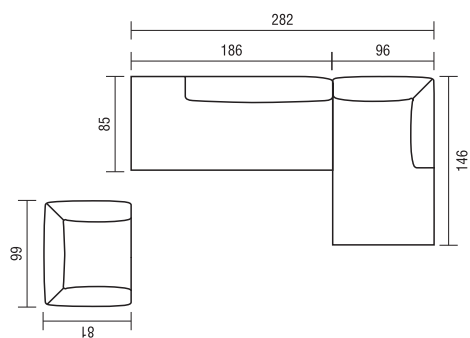

- | | | |
|--------------------|--------------------|---------------------|
| 1 chaise longue DX | 1 chaise longue DX | 1 Chaiselongue DX |
| 1 terminale 186 SX | 1 end piece 186 SX | 1 Endelement 186 SX |
| 1 poltrona | 1 armchair | 1 Sessel |

Foto pagina - photo at page - Bid auf Seiten: 10/11

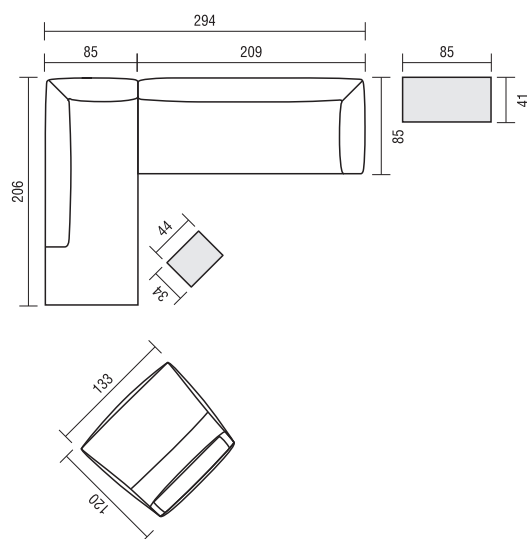

- | | | |
|------------------------------|--------------------------------|------------------------------|
| 1 dormeuse angolo SX | 1 corner dormeuse SX | 1 Eckdormeuse SX |
| 1 laterale 209 DX | 1 side piece 209 DX | 1 Seitenteil 209 DX |
| 1 Zoe poltrona XL | 1 Zoe XL armchair | 1 Zoe XL Sessel |
| 1 tavolino Blog rettangolare | 1 Blog rectangular small table | 1 rechteckiger Beistelltisch |
| 1 tavolino Blog XL | 1 Blog coffee table XL | 1 Beistelltisch XL |

FINITURE - FINISHING - AUSFÜHRUNGEN



Cucitura Punto Cavallo
Stitching Punto Cavallo
Ziernaht Punto Cavallo



Cucitura ribattuta semplice
Single lapped seam
einfache Kappnaht

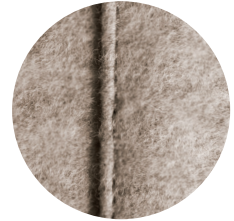

Cucitura versione tessuto Punto Cavallo
Fabric version stitching Punto Cavallo
Stoffversion Zierstich Punto Cavallo



Cucitura versione pelle solo ribattuta semplice con tasca chiusa
Leather version single lapped seam only closed pocket
Lederversion einfache Kappnaht Nur mit geschlossener Falte