



Caratteristiche: Linea elegante dalle studiate proporzioni conquista slancio e leggerezza grazie al piede a ponte in alluminio su cui poggia la struttura. La collezione offre un'ampia gamma di divani, elementi, laterali, angoli, chaise-longue, dormeuse e pouf per un totale di 96 moduli diversi, che abbinati a piacere, offrono la possibilità di creare innumerevoli combinazioni. Una poltrona di dimensioni contenute completa la gamma. Hampton offre la possibilità di scegliere fra due differenti versioni di schienale: con schienali rettangolari (tipo "A") o con cuscini-schienale (tipo "B" cm. 57x57) in quantità predefinita. Per permettere una maggiore personalizzazione Hampton si può scegliere anche nella versione "BASE" (senza cuscini-schienale) da completare con i cuscini-schienale scelti fra le diverse misure in collezione. Comodi poggiatesta, cuscini-schienale e cuscini in diverse misure sono disponibili come optional. I cuscini di seduta sono disponibili, a seconda dei moduli, sia con il cuscino unico sia con i cuscini divisi. Per i divani (con due braccioli) e la poltrona, la fodera della struttura, di serie tesa, si può realizzare anche con gonna. Con gonna i piedi sono cilindrici. Il rivestimento è completamente e facilmente sfoderabile. Hampton è attrezzabile con i tavolini: Argo, Blog e Jim. **Struttura:** Fusto in legno massello e multistrato, imbottito in poliuretano espanso indeformabile a densità differenziata, molleggio con nastri elastici intrecciati. Prerivestimento con tela di cotone accoppiata con fibra poliestere. Il piede, nella versione tesa, è a ponte: di serie in fusione di alluminio brunito e, su richiesta, in fusione di alluminio lucidato. Nella versione con gonna (divani e poltrona) i piedi sono cilindrici. In entrambe le versioni è disponibile, solo su richiesta, il piede più alto di cm. 3 rispetto allo standard. **Imbottiture cuscini:** Cuscini-schienale tipo "A" in piuma canalizzata con inserto in poliuretano; cuscini-schienale tipo "B" interamente in piuma canalizzata. Di serie i cuscini di seduta sono in piuma canalizzata con inserto in poliuretano a densità differenziata. Il cuscino di seduta in piuma e poliuretano offre un comfort speciale, proprio della piuma, che dona alle imbottiture un aspetto piacevolmente vissuto che va accettato in quanto inevitabile. Su richiesta si forniscono i cuscini di seduta in poliuretano a densità differenziata e fibra poliestere. In entrambi i casi i cuscini di seduta sono disponibili, a seconda dei moduli, sia con il cuscino unico sia con i cuscini divisi. Tutte le imbottiture sono interamente prerivestite con tela bianca.

Features: Elegant line and studied proportions, which obtain burst and determination through its bridge-shaped foot supporting the framework. This collection offers a wide range of sofas, elements, side pieces, corners, chaise-longue, dormeuse, and poufs for a total number of 96 different modules, which can be freely combined and give the possibility to create countless combinations. A small armchair completes the range. Hampton offers the possibility to choose between two different backrest versions: with rectangular backrests (type "A") or with backrest-cushions (type "B" 57x57 cm) in a predefined quantity. To allow more customization possibilities, Hampton is also available in the "BASE" version (without backrests cushions) to be completed with backrest-cushions selected among the various sizes in the collection. Comfortable lumbar cushions, backrest-cushions, and cushions in various sizes are available as optional. The seat cushions are available, according to the modules, either unique or divided. For the sofas (with two arms) and armchair, the framework cover, of the tensed series, can also be made with skirting. With skirting, the feet are cylindrical. The cover can be completely and easily removed. Hampton can be equipped with tables: Argo, Blog, and Jim. **Framework:** Frame made of solid and plywood, padded with non-deformable expanded polyurethane of differentiated density, and sprung with interwoven elastic belts. Cotton lining coupled with polyester fibre. In the version without skirt, the foot is bridge-shaped: burnished cast aluminium series and polished cast aluminium, upon request. In the version with skirting (sofas and armchair) the foot is cylindrical. Upon request both versions are available with feet 3 cm higher than standard. **Cushion padding:** Backrest-cushions type "A" with canalised feather and polyurethane insert; Backrest-cushions type "B" entirely made with canalised feather. The standard seat cushions are made with canalised feather and polyurethane insert with differentiated density. The seat cushion with feather and polyurethane provides the typical special comfort of feather, as well as a pleasantly used aspect of padding, which has to be accepted as it cannot be avoided. Differentiated density polyurethane and polyester fibre seat cushions are available upon request. In both versions, and according to the modules, the seat cushions can be either unique or divided. All padding is fully lined with white fabric.

Eigenschaften: Schmale, brückenförmige Aluminiumfüße, die die gesamte Struktur stützen, betonen die elegante und harmonische Form des Modells. Hampton bietet eine große Bandbreite an Modulen: Sofas, Seitenteile, Eckstücke, Chaiselongue, Dormeuse und Hocker – insgesamt 96 verschiedene, individuell kombinierbare Elemente. Ein kleiner Sessel vervollständigt die Kollektion. Zwei Rückenlehnen stehen zur Auswahl: die traditionelle mit geraden, rechteckigen Rückenkissen (Typ A) oder die Variante mit quadratischen Wurfkissen (57 x 57 cm Typ B), mit einer, je nach Element, vorgegebenen Standardanzahl. Mehr Individualität bei der Zusammenstellung des Sofasystems ermöglicht die Version „BASIS“ ohne Standard-Rückenkissen. Diese werden durch Wurfkissen unterschiedlicher Maße ersetzt. Die Option bequemer Lendenstützen, Rückenkissen und verschiedener Kissen-Varianten erleichtern die Erfüllung individueller Ansprüche an Komfort und Ästhetik. Die Sitzkissen sind, je nach Element, als durchgehendes oder als geteilte Einzelkissen erhältlich. Die Sofas (mit zwei Armlehnen) und der Sessel können entweder mit einem Bezug ohne oder mit Volant realisiert werden. Bei Bezügen mit Volant sind die Füße zylindrisch. Die Bezüge sind leicht und vollständig abziehbar. Die Beistelltische Argo, Blog und Jim ergänzen das Angebot. **Struktur:** Der Rahmen besteht aus Massiv- und Mehrschichtholz, gepolstert mit formstabilem Polyurethan unterschiedlicher Dichten und einer Federung mit geflochtenen elastischen Gurten. Das Polster schützt ein Unterbezug aus weißem Baumwollstoff mit Polyesterfaser. Bei Bezügen ohne Volant sind die Füße schmal und brückenartig geformt; serienmäßig in Aluminiumguss brüniert und, auf Anfrage, poliert. Bei Bezügen mit Volant sind die Füße zylindrisch und vom Bezug verdeckt. Auf Anfrage sind beide Versionen mit einem um 3 cm höheren Fuß, verglichen mit der Standardausführung, erhältlich. **Polster:** Rückenkissenfüllung Typ-A mit Federn und einem zusätzlichen Polyurethanking; Typ-B ausschließlich aus Federn; in beiden Fällen in Kammern gesteppt. Die Standard-Sitzkissen haben eine Federfüllung mit einem Polyurethanking unterschiedlicher Dichte. Die Sitzkissen-Variante mit Federn und Polyurethan bietet besonderen Sitzkomfort, bringt jedoch die für diese Art von Füllung typischen Sitzkuhlen mit sich. Auf Anfrage werden die Sitzkissen auch in differenziertem Polyurethan und Polyesterfasern geliefert. Beide Versionen sind, je nach Element, sowohl als durchgehende als auch als geteilte Sitzkissen, lieferbar. Alle Polster haben einen weißen Schonbezug.

PIEDE FOOT FUß

Fusione di alluminio brunito (di serie);
fusione di alluminio lucidato (su richiesta).
Burnished cast aluminium (series);
polished cast aluminium (upon request).
Standardausführung in Aluminiumguss brüniert;
Auf Anfrage in Aluminiumguss poliert.

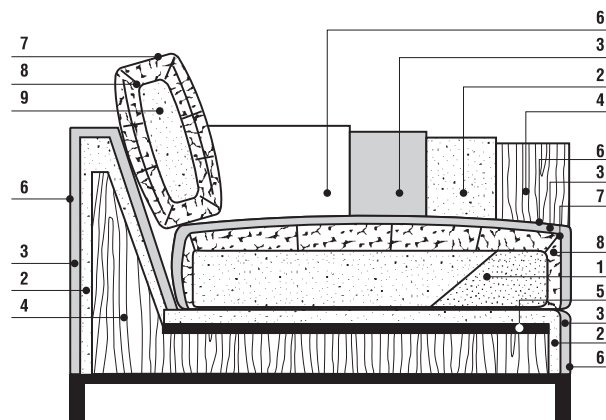

SEZIONE SECTION SEKTION

- 1: Poliuretano a densità differenziata.
Differentiated density polyurethane.
Polyurethan unterschiedlicher Dichte.
- 2: Poliuretano. Polyurethane. Polyurethan.
- 3: Fibra Poliestere. Polyester Fibre.
Polyesterfaser.
- 4: Fusto in legno massello e multistrato.
Frame in solid wood and plywood.
Rahmen aus Massivholz, oder schichtverleimt.
- 5: Nastri elastici. Elastic belts. Elastische Gurte.
- 6: Fodera in tela. Fabric lining. Stoff-Futter.
- 7: Fodera in tessuto antipiuma.
Featherproof fabric cover.
Daunenunterchlässiger Bezug des Kisseninlets.
- 8: Piuma. Down. Daunenfüllung.
- 9: Inserto in Poliuretano. Polyurethane insert.
Kern aus Polyurethan.

HAMPTON VERSIONE A

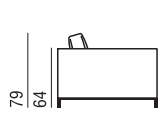

FIANCO

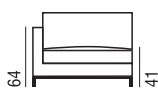

FRONTE
SEZ. DEL BRACCIOLO

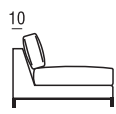

SEZ. DEL FIANCO

HAMPTON VERSIONE B

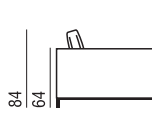

FIANCO

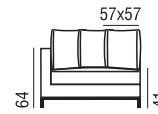

FRONTE

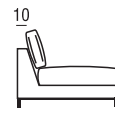

SEZ. DEL FIANCO

HAMPTON VERSIONE A

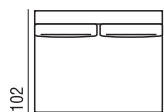

136

ELEMENTO 136 A

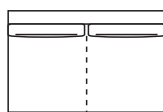

167

ELEMENTO 167 A
cuscino unico/cuscini divisi

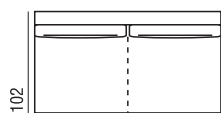

198

ELEMENTO 198 A
cuscino unico/cuscini divisi

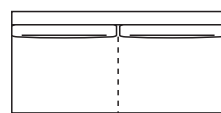

226

ELEMENTO 226 A
cuscino unico/cuscini divisi

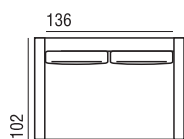

156

DIVANO 156 A

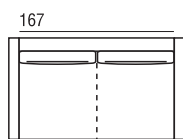

187

DIVANO 187 A
cuscino unico/cuscini divisi

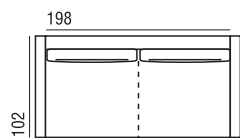

218

DIVANO 218 A
cuscino unico/cuscini divisi

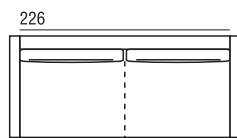

246

DIVANO 246 A
cuscino unico/cuscini divisi

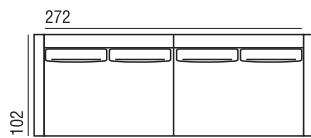

292

DIVANO 292 A
composto da 2 laterali 146 SX e DX

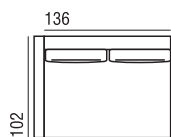

146

LATERALE 146 SX A

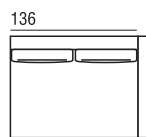

146

LATERALE 146 DX A

HAMPTON VERSIONE B

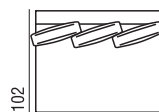

136

ELEMENTO 136 B

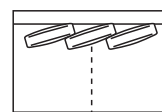

167

ELEMENTO 167 B
cuscino unico/cuscini divisi

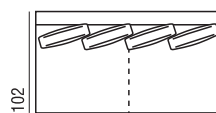

198

ELEMENTO 198 B
cuscino unico/cuscini divisi

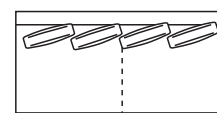

226

ELEMENTO 226 B
cuscino unico/cuscini divisi

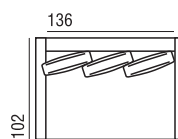

156

DIVANO 156 B

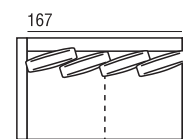

187

DIVANO 187 B
cuscino unico/cuscini divisi

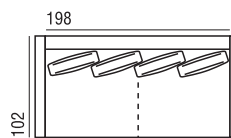

218

DIVANO 218 B
cuscino unico/cuscini divisi

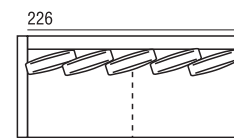

246

DIVANO 246 B
cuscino unico/cuscini divisi

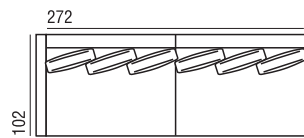

292

DIVANO 292 B
composto da 2 laterali 146 SX e DX

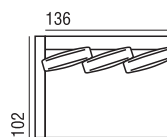

146

LATERALE 146 SX B

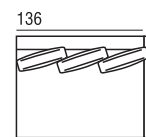

146

LATERALE 146 DX B

HAMPTON VERSIONE A

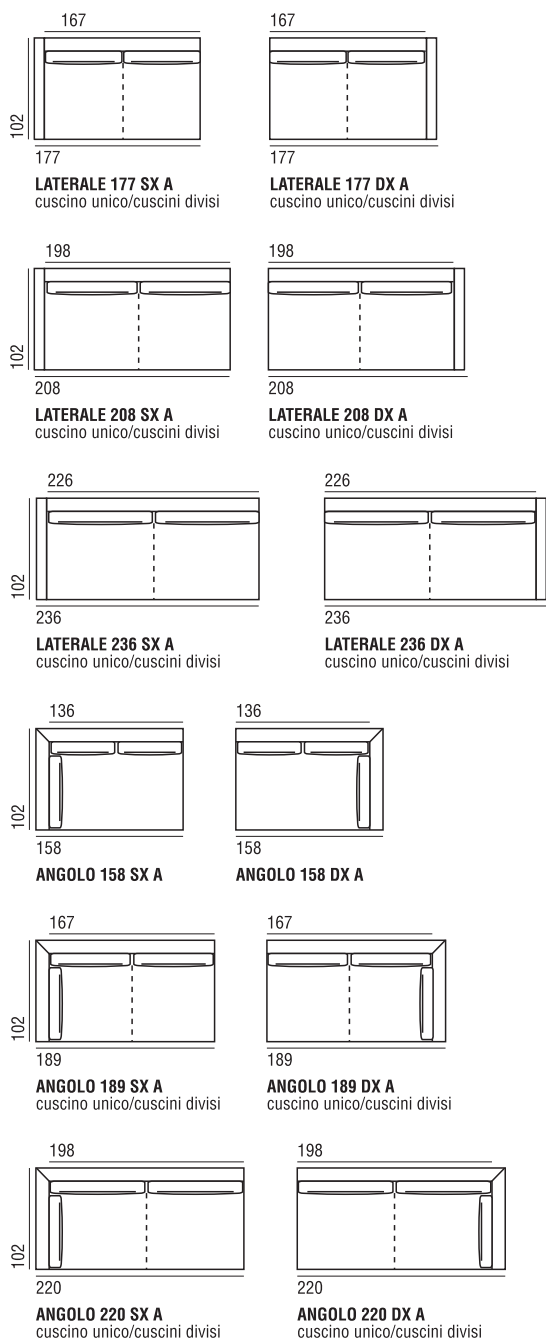

HAMPTON VERSIONE B

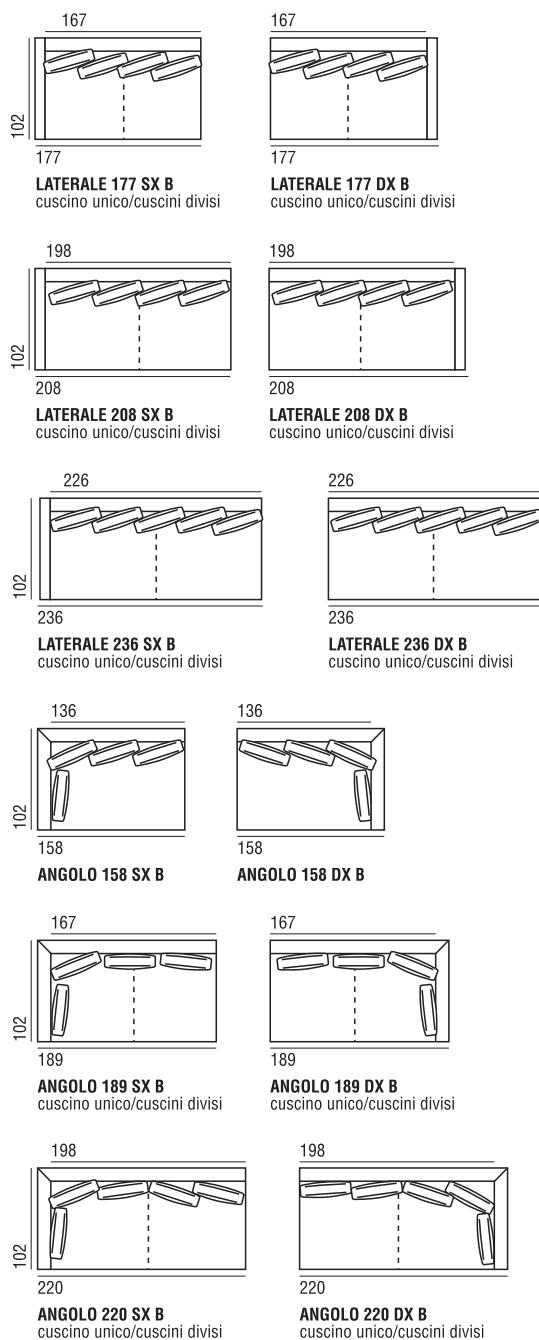

HAMPTON VERSIONE A

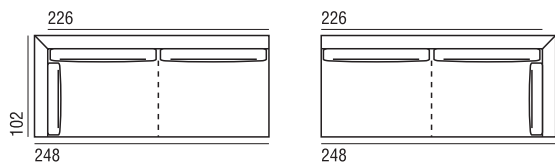

ANGOLO 248 SX A
cuscino unico/cuscini divisi

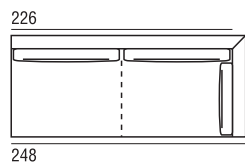

ANGOLO 248 DX A
cuscino unico/cuscini divisi

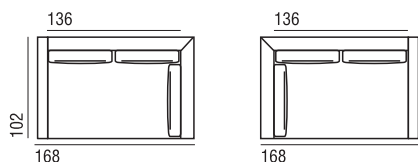

ANGOLO LATERALE 168 SX A

ANGOLO LATERALE 168 DX A

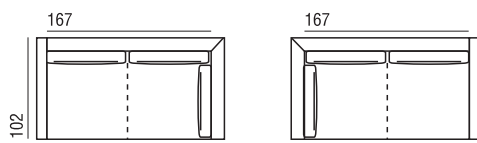

ANGOLO LATERALE 199 SX A
cuscino unico/cuscini divisi

ANGOLO LATERALE 199 DX A
cuscino unico/cuscini divisi

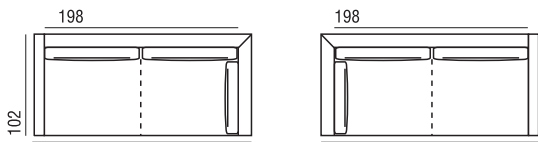

ANGOLO LATERALE 230 SX A
cuscino unico/cuscini divisi

ANGOLO LATERALE 230 DX A
cuscino unico/cuscini divisi

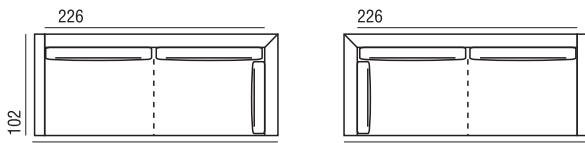

ANGOLO LATERALE 258 SX A
cuscino unico/cuscini divisi

ANGOLO LATERALE 258 DX A
cuscino unico/cuscini divisi

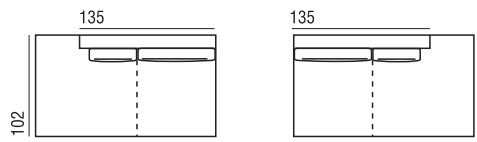

TERMINALE 180 SX A
cuscino unico/cuscini divisi

TERMINALE 180 DX A
cuscino unico/cuscini divisi

HAMPTON VERSIONE B

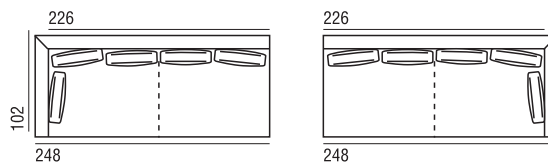

ANGOLO 248 SX B
cuscino unico/cuscini divisi

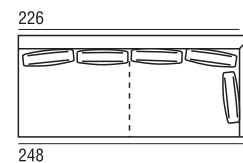

ANGOLO 248 DX B
cuscino unico/cuscini divisi

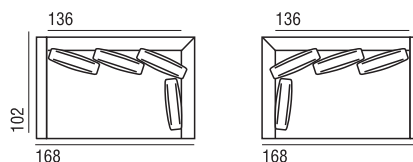

ANGOLO LATERALE 168 SX B

ANGOLO LATERALE 168 DX B

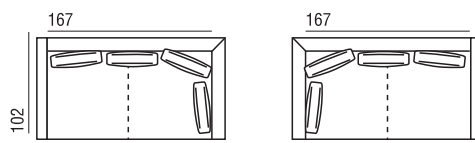

ANGOLO LATERALE 199 SX B
cuscino unico/cuscini divisi

ANGOLO LATERALE 199 DX B
cuscino unico/cuscini divisi

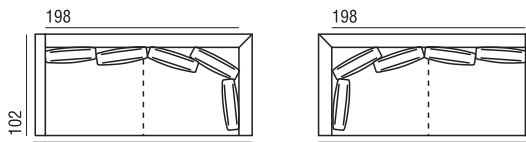

ANGOLO LATERALE 230 SX B
cuscino unico/cuscini divisi

ANGOLO LATERALE 230 DX B
cuscino unico/cuscini divisi

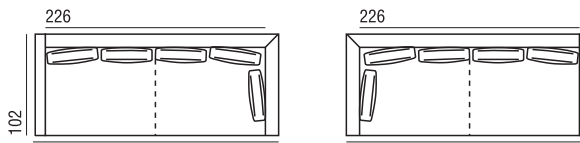

ANGOLO LATERALE 258 SX B
cuscino unico/ cuscini divisi

ANGOLO LATERALE 258 DX B
cuscino unico/cuscini divisi

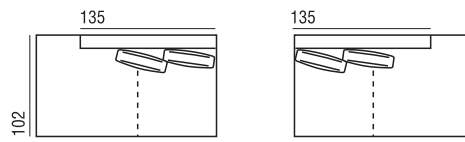

TERMINALE 180 SX B
cuscino unico/cuscini divisi

TERMINALE 180 DX B
cuscino unico/cuscini divisi

HAMPTON VERSIONE A

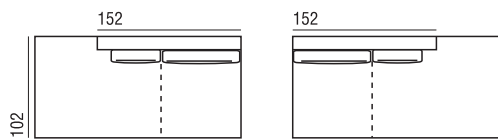

218
TERMINALE 218 SX A
cuscino unico/cuscini divisi

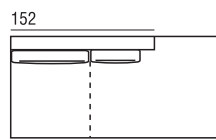

218
TERMINALE 218 DX A
cuscino unico/cuscini divisi

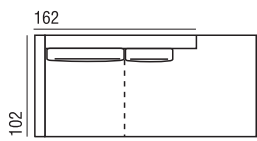

228
DORMEUSE 228 SX A
cuscino unico/cuscini divisi

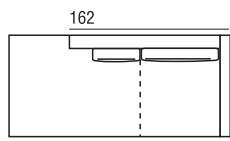

228
DORMEUSE 228 DX A
cuscino unico/cuscini divisi

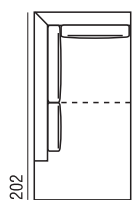

102
DORMEUSE ANGOLO 202 SX A
cuscino unico/cuscini divisi

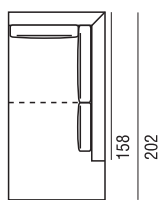

102
DORMEUSE ANGOLO 202 DX A
cuscino unico/cuscini divisi

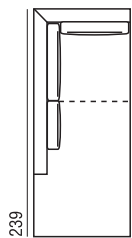

102
DORMEUSE ANGOLO 239 SX A
cuscino unico/cuscini divisi

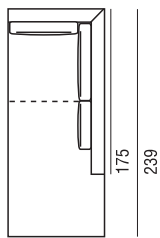

102
DORMEUSE ANGOLO 239 DX A
cuscino unico/cuscini divisi

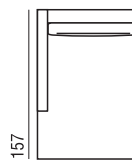

110
CHAISE LONGUE 110 SX A

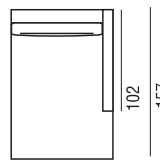

110
CHAISE LONGUE 110 DX A

HAMPTON VERSIONE B

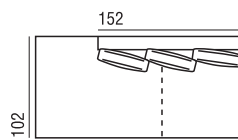

218
TERMINALE 218 SX B
cuscino unico/cuscini divisi

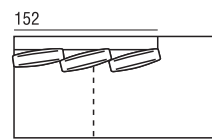

218
TERMINALE 218 DX B
cuscino unico/cuscini divisi

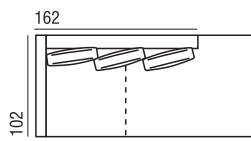

228
DORMEUSE 228 SX B
cuscino unico/cuscini divisi

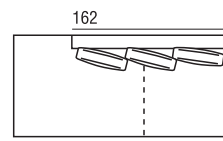

228
DORMEUSE 228 DX B
cuscino unico/cuscini divisi

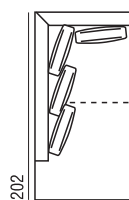

102
DORMEUSE ANGOLO 202 SX B
cuscino unico/cuscini divisi

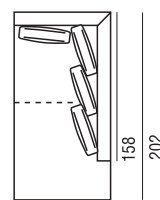

102
DORMEUSE ANGOLO 202 DX B
cuscino unico/cuscini divisi

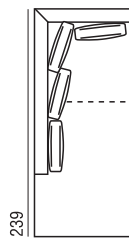

102
DORMEUSE ANGOLO 239 SX B
cuscino unico/cuscini divisi

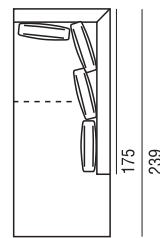

102
DORMEUSE ANGOLO 239 DX B
cuscino unico/cuscini divisi

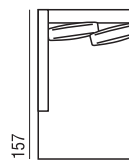

110
CHAISE LONGUE 110 SX B

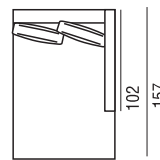

110
CHAISE LONGUE 110 DX B

HAMPTON VERSIONE A

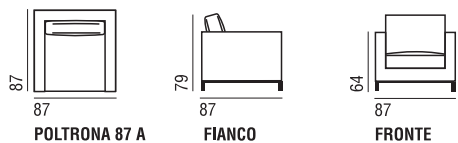

HAMPTON VERSIONE B

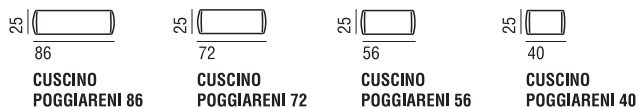
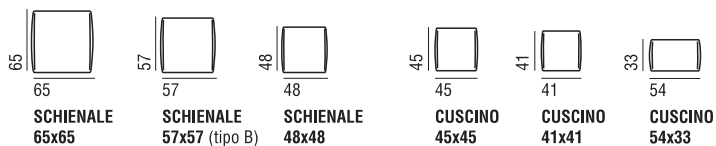
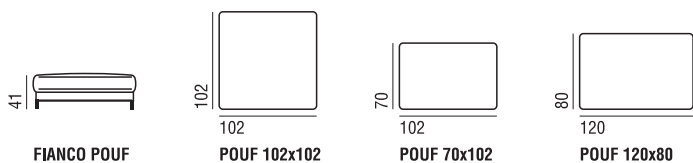
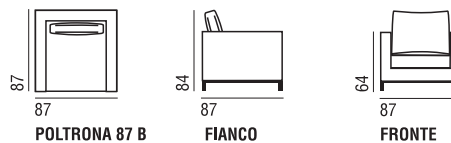

COMPLEMENTI

BLOG TAVOLINO ROTONDO design Lievore Altherr Molina (2006)

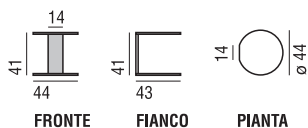

BLOG TAVOLINO RETTANGOLARE design Lievore Altherr Molina (2006)

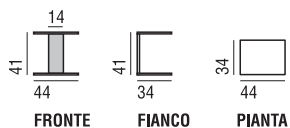

BLOG TAVOLINO XL design Lievore Altherr Molina (2013)



TAVOLINO ARGO design Lievore Altherr Molina (2006)

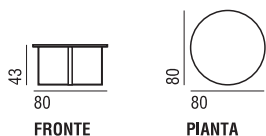

TAVOLINO JIM design Lievore Altherr Molina (2010)

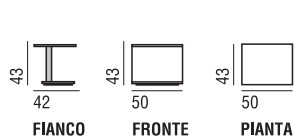

TAVOLINO JULES design Lievore Altherr Molina (2010)

